

Revisions to this document are noted by a stripe in the left-hand margin

#2001, Rev. B  
August 16, 2019  
Product Code(s): 66 and 65  
Page 1 of 2

SUBJECT: Filter Cover Bolt Hole Repair Kit

MODELS AFFECTED: All 3000 and 4000 Series Product Families Transmission Models

### Introduction:

To facilitate the repair of the filter cover bolt threads in the main case a Filter Cover Bolt Hole Repair Kit, *J-42385-AT* has been released. The kit can be used for thread repair with any 3000 and 4000 Product Families model. The kit allows the threads to be repaired in or out of chassis. The kit utilizes a solid, thin-walled, self-locking steel bushing insert to repair the filter cover bolt threads in the main housing of the transmission. The thread inserts repair the filter cover bolt threads to their original thread specification of an M10 x 1.5.

The Filter Cover Bolt Hole Repair Kit contains:

- Template J-42385-230 (Main Filter)
- Template J-42385-234 (Lube Filter)
- Two (2) Alignment Pins J-42385-308
- M10 Step Drill J-42385-231
- Tap J-42385-232
- 60 Inserts J-42385-514, the kit contains six (6) packets of ten (10) M10 x 1.5 x 24.5
- Insert Driver J-42385-233
- Tap Wrench 510260
- Six (6) M10 Retaining Bolts 206158
- Driver Oil J-42385-110

The kit contains 60 inserts and 1 bottle of oil. Additional inserts and oil can be purchased through Bosch Automotive Service Solutions LLC.

Bosch Automotive Service Solutions LLC  
28635 Mound Road  
Warren, MI 48092-3499  
US and CANADA: 1-866-621-2128  
INTERNATIONAL: 1-507-455-7223  
FAX: 1-800-578-7375  
<https://allison.service-solutions.com>

3000 and 4000 series transmissions have been manufactured with two versions of filter cover bolt patterns. It is important to first determine which version is being repaired before proceeding. Transmissions manufactured prior to 2002 have M10 x 1.50 tapped holes in the main housing that accept the filter cover bolts directly. Around late 2002 the main housing configuration was changed with the addition of factory installed helicoil inserts in the filter cover bolt patterns.

It is necessary to first inspect the housing being repaired to determine if factory installed helicoil inserts are present. The instruction sheet included in the Filter Cover Bolt Hole Repair Kit, J-42385-AT has been modified to include two separate repair processes, one for housings without helicoil inserts and a second for housings with helicoil inserts. Use the applicable process for the housing being repaired.



**WARNING:** For housings without factory installed helicoil inserts, prior to beginning the repair, the filter cover bolt holes must be inspected to assure the M10 Step Drill (J-42385-231) can properly prepare the hole for thread cutting with the Tap J-42385-232. If any of the filter cover bolt holes are found oversized the transmission main housing must be replaced.



**WARNING:** For housings with factory installed helicoil inserts, it is important to remove the helicoil inserts from all holes before cutting the needed countersink with the M10 Step Drill J-42385-231. The countersink is needed for proper installation of the Thread Repair Kit inserts. The Allison factory installed helicoil inserts use the same hole and thread size as the Thread Repair Kit inserts – so the kit's J-42385-232 Tap should not be run afterward. When cutting the countersink with the step drill, take care to avoid damaging the existing threads with the drill.

#### **Field Repair Procedures:**

The two attached Instruction Sheets (with & without factory installed helicoils) must be used to facilitate the repair of the filter cover bolt threads in the main housing.



# BOSCH

## Automotive Service Solutions

### J-42385-AT Filter Cover Bolt Hole Repair Kit (Without Helicoils) Allison Transmission

#### Step 1

Remove control module from the transmission. Refer to appropriate service manual for correct removal procedure.

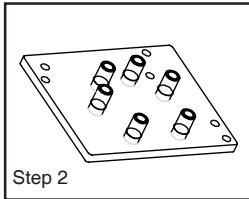

Step 2

#### Step 2

Determine correct drill fixture for hole pattern to be repaired (i.e. "Main J-42385-230" or "Lube J-42385-234"). Locate FRONT of fixture to front of transmission.

#### Step 3

Align the fixture using two alignment pins. Secure the plate with three attachment bolts.

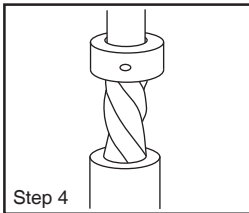

Step 4

#### Step 4

Use the step drill bit J-42385-231 with an electric drill to drill out the damaged thread. Collar on drill must contact the guide. Clean out ALL chips or foreign material.

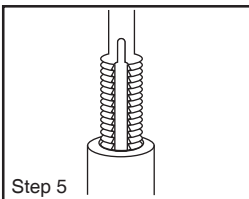

Step 5

#### Step 5

Use Tap J-42385-232 and Tap Wrench 510260 to thread new hole. Tap must bottom to ensure thread depth. Clean out ALL chips or foreign material. Retap if necessary.

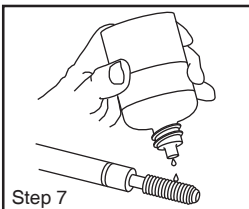

Step 7

#### Step 6

Remove fixture. Verify holes are free of chips or debris.

#### Step 7

Lubricate the threads of the driver tool with J-42385-110 driver oil.

#### Step 8

Install the insert onto the Driver Tool J-42385-233. Do not allow oil or foreign material to contact the outside of the insert.

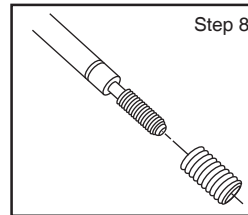

Step 8

#### Step 9

Install the insert into the hole until it is seated in the counterbore. Continue to rotate the driver through the insert. The driver will tighten up before screwing completely through the insert. This is normal because the bottom threads of the insert are being formed and mechanically locked into the hole. Lightly bottom the driver in the hole to ensure complete threading and insert lock-in. Remove the driver, and the repair is complete.

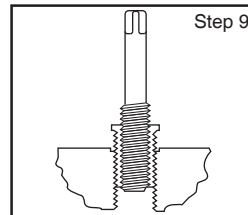

Step 9

#### Step 10

Inspect the insert for correct installation. It must be flush or below the base surface.

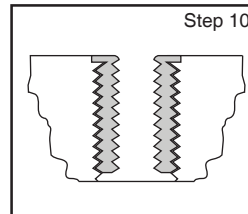

Step 10

Kit Contains	Part Number	Qty.
Driver Oil	J-42385-110	1 bottle
Drill Fixture- Main	J-42385-230	1
Step Drill Bit	J-42385-231	1
Tap	J-42385-232	1
Driver	J-42385-233	1
Drill Fixture- Lube	J-42385-234	1
Alignment Pin	J-42385-308	2
Thread Inserts (bag of 10)	J-42385-514	6
Tap Wrench	510260	1
Attachment Bolts	206158	6

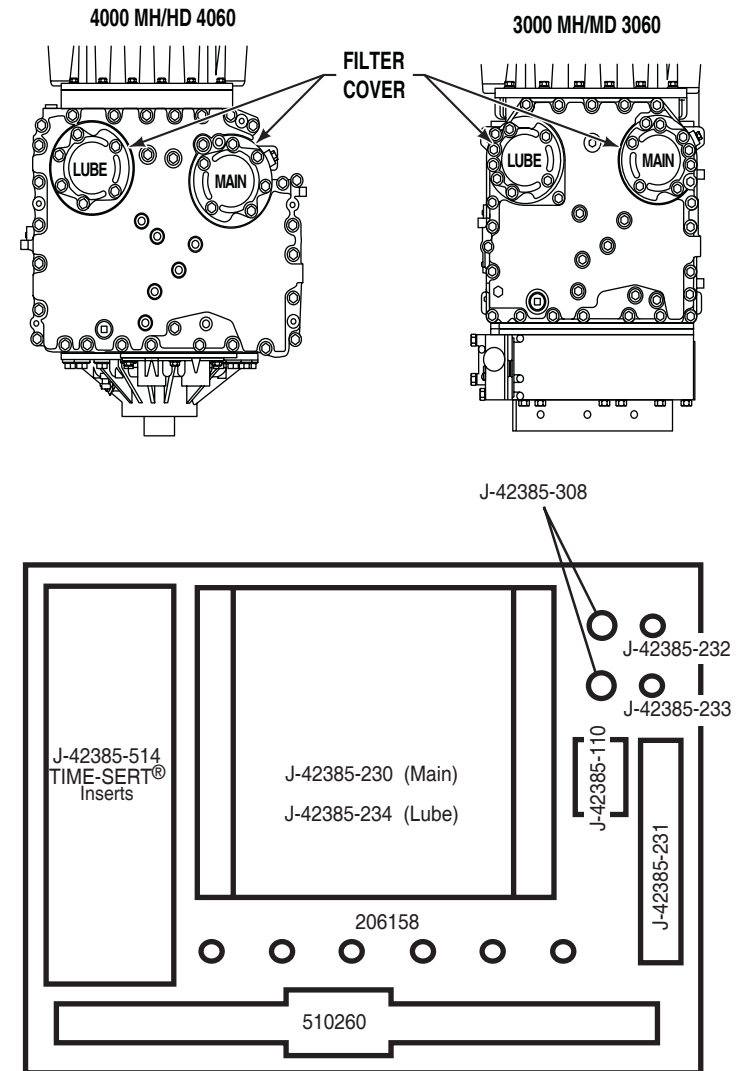

#### IMPORTANT

- Cutting fluid, such as WD40 or equivalent, is recommended for all drilling and tapping operations.
- Driver oil J-42385-110 must be used on the insert driver
- After each cutting operation, clean out metal chips using compressed air
- Do not allow metal chips to enter the transmission. Cover and clean components as necessary

**WARNING:** Always wear safety glasses when performing this task.

**WARNING:** The Allison factory installed steel inserts use the same hole and thread size as the Thread Repair Kit inserts; however, the M10 Step Drill J-42385-231 must be used to countersink the existing holes before the Thread Repair inserts are installed. Take care to avoid damaging the existing threads with the step drill when machining the countersinks.



# BOSCH

## Automotive Service Solutions

### J-42385-AT Filter Cover Bolt Hole Repair Kit (With Helicoils) Allison Transmission

#### Step 1

Remove control module from the transmission. Refer to appropriate service manual for correct removal procedure.

#### Step 1a

Remove helicoils with pliers and dispose – taking care when doing so not to damage the tapped holes in the housing.

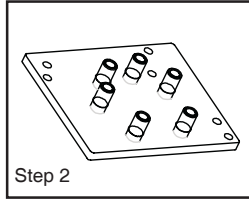

#### Step 2

Determine correct drill fixture for hole pattern to be repaired (i.e. "Main J-42385-230" or "Lube J-42385-234"). Locate FRONT of fixture to front of transmission.

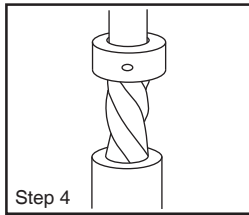

#### Step 3

Align the fixture using two alignment pins. Secure the plate with three attachment bolts.

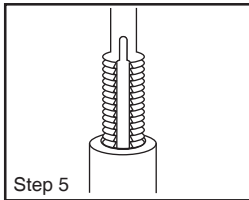

#### Step 4

Use the step drill bit J-42385-231 with an electric drill to drill out the damaged thread. Collar on drill must contact the guide. Clean out ALL chips or foreign material.

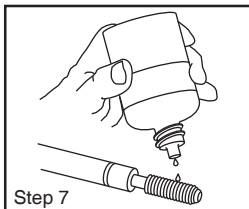

#### Step 5

Clean out ALL chips or foreign material. Retap if necessary.

#### Step 6

Remove fixture. Verify holes are free of chips or debris.

#### Step 7

Lubricate the threads of the driver tool with J-42385-110 driver oil.

#### Step 8

Install the insert onto the Driver Tool J-42385-233. Do not allow oil or foreign material to contact the outside of the insert.

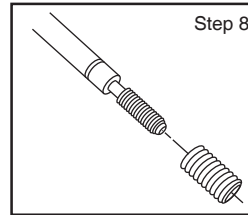

#### Step 9

Install the insert into the hole until it is seated in the counterbore. Continue to rotate the driver through the insert. The driver will tighten up before screwing completely through the insert. This is normal because the bottom threads of the insert are being formed and mechanically locked into the hole. Lightly bottom the driver in the hole to ensure complete threading and insert lock-in. Remove the driver, and the repair is complete.

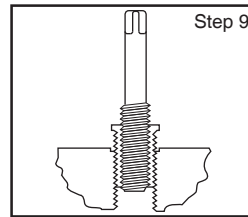

#### Step 10

Inspect the insert for correct installation. It must be flush or below the base surface.

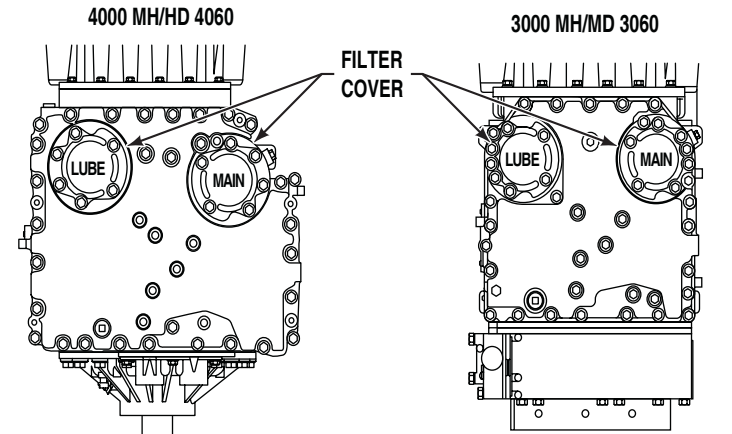
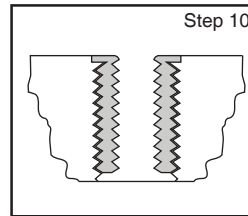

Kit Contains	Part Number	Qty.
Driver Oil	J-42385-110	1 bottle
Drill Fixture- Main	J-42385-230	1
Step Drill Bit	J-42385-231	1
Tap	J-42385-232	1
Driver	J-42385-233	1
Drill Fixture- Lube	J-42385-234	1
Alignment Pin	J-42385-308	2
Thread Inserts (bag of 10)	J-42385-514	6
Tap Wrench	510260	1
Attachment Bolts	206158	6

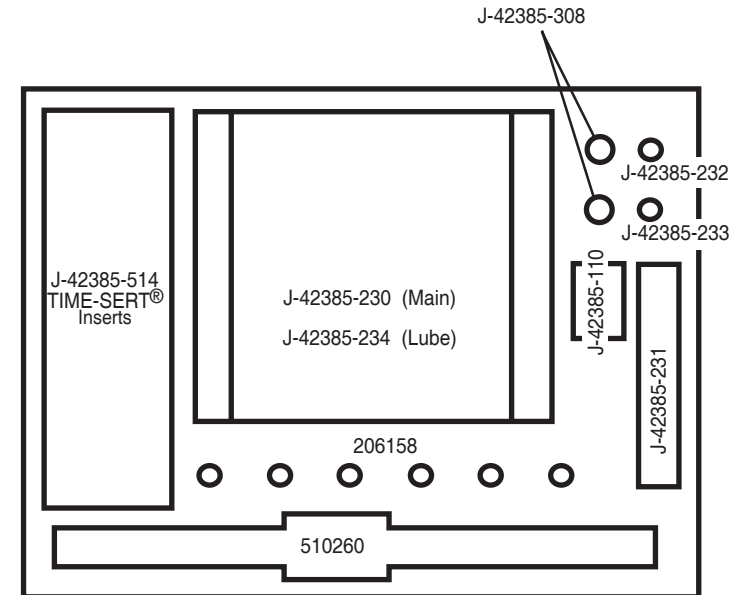

#### IMPORTANT

- Cutting fluid, such as WD40 or equivalent, is recommended for all drilling and tapping operations.
- Driver oil J-42385-110 must be used on the insert driver.
- After each cutting operation, clean out metal chips using compressed air.
- Do not allow metal chips to enter the transmission. Cover and clean components as necessary.

**WARNING:** Always wear safety glasses when performing this task.

**WARNING:** The Allison factory installed steel inserts use the same hole and thread size as the Thread Repair Kit inserts; however, the M10 Step Drill J-42385-231 must be used to countersink the existing holes before the Thread Repair inserts are installed. Take care to avoid damaging the existing threads with the step drill when machining the countersinks.